



100 Series Temperature Switch

Types B100, C100, **E100**, F100



UNITED ELECTRIC
CONTROLS

Installation and Maintenance Instructions

Please read all instructional literature carefully and thoroughly before starting. Refer to the final page for the listing of Recommended Practices, Liabilities and Warrantees. For functional safety applications, please refer to the safety manual which can be downloaded from www.ueonline.com

GENERAL

The 100 Series temperature switch utilizes either a liquid filled sensing stem (immersion stem, direct mounting) or liquid filled sensing bulb (bulb & capillary, remote mounting) to detect a temperature change. The response at a pre-determined set point actuates a SPDT snap-acting microswitch, converting the temperature signal into an electrical signal. Control set point may be varied by turning the internal adjustment hex (C100, F100) or reference dial (B100, E100) according to the procedures outlined (See Part II – Adjustments).



MAXIMUM TEMPERATURE* STATED IN LITERATURE AND ON NAMEPLATE MUST NEVER BE EXCEEDED, EVEN BY SURGES IN THE SYSTEM. OCCASIONAL OPERATION OF UNIT UP TO MAX. TEMPERATURE IS ACCEPTABLE (E.G., START-UP, TESTING). CONTINUOUS OPERATION SHOULD BE RESTRICTED TO THE DESIGNATED ADJUSTABLE RANGE.

*Maximum Temperature - the highest temperature to which a sensing element may be occasionally operated without adversely affecting set point calibration and repeatability.



THESE PRODUCTS DO NOT HAVE ANY FIELD REPLACEABLE PARTS.

Please refer to the product technical brochure for product specifications. Product technical brochures may be found at www.ueonline.com.

Part I - Installation

Tools Needed

Adjustable wrench
Flathead screwdriver
Hammer (for alternate wire knockouts)

MOUNTING



ALWAYS LOCATE UNITS WHERE SHOCK, VIBRATION AND TEMPERATURE FLUCTUATIONS ARE MINIMAL. DO NOT MOUNT UNIT IN AMBIENT TEMPERATURES EXCEEDING PUBLISHED LIMITS.



UNIT MAY BE MOUNTED IN ANY POSITION PROVIDED THE ELECTRICAL CONDUIT IS NOT FACING UP. THE RECOMMENDED MOUNTING POSITION IS VERTICAL (PRESSURE CONNECTION FACING DOWN), SPECIFICALLY WHERE HEAVY CONDENSATION IS EXPECTED.

For remote mounting, mount the unit via the (2) 1/4" screw clearance holes on the enclosure (See Dimensions on back page.) Fully immerse the bulb and 6" capillary in the control zone. It is generally desirable to place the bulb close to the heating or cooling source in order to sense temperature fluctuations quickly. Be sure to locate the bulb so that it will not be exposed to temperatures beyond the instrument range limits.



ALWAYS HOLD A WRENCH ON THE TEMPERATURE HOUSING HEX WHEN MOUNTING UNIT. DO NOT TIGHTEN BY TURNING ENCLOSURE. THIS WILL DAMAGE SENSOR AND WEAKEN SOLDERED OR WELDED JOINTS.

On models supplied with an external manual reset button, be sure to leave sufficient finger space over the reset button for the operator to reset the control.

WIRING



DISCONNECT ALL SUPPLY CIRCUITS BEFORE WIRING UNIT. WIRE UNITS ACCORDING TO NATIONAL AND LOCAL ELECTRICAL CODES. MAXIMUM RECOMMENDED WIRE SIZE IS 14 AWG. THE RECOMMENDED TIGHTENING TORQUE FOR FIELD WIRING TERMINALS IS 7 TO 17 IN-LBS.



ELECTRICAL RATINGS STATED IN LITERATURE AND ON NAMEPLATE SHOULD NEVER BE EXCEEDED. OVERLOAD ON A SWITCH CAN CAUSE FAILURE ON THE FIRST CYCLE.

Remove the two screws retaining the cover and cover gasket. A 1/2" NPT conduit connection is located on the left side of the enclosure. Two cast-in 7/8" diameter knockouts for electrical conduit are located on the side and rear of enclosure. These can easily be knocked out by placing the blade of a screwdriver in the groove and tapping sharply with a hammer.

Connect conduit to the enclosure and wire directly to the switch terminals according to local and national electrical codes. Bring the wires up to terminals from the rear of the enclosure allowing enough slack so as not to affect switch movement when making setting adjustments. The three switch terminals are clearly labeled "common", "norm open", and "norm closed". If lead wires are supplied, color coding is as follows:

Manual Reset Option 1530 SPDT

Common (COM)	Violet
Normally Open (NO)	Blue
Normally Closed (NC)	Black

A grounding screw and clamp (cast in symbol) is provided which meets a 35 lb. pull test. Keep the wire as short as possible to prevent interference with the plunger and, if applicable, the optional adjustable deadband switch wheel (option1519).

Part II - Adjustments

Tools Needed

3/16" open end wrench

NOTE: For set point adjustments and recalibration, immerse sensor (immersion stem or bulb and 6" of capillary) in a calibrated temperature source and stabilize unit.

Types C100 and F100

Remove cover. Switch has a hex adjustment screw inside enclosure (See Figure 1). If switch transfer point differs from actual temperature, adjust setting. To raise the temperature setting, turn the hex towards the left (clockwise). To lower the temperature setting, turn the screw towards the right (counter-clockwise). When making adjustments, do not exceed the maximum temperature rating on nameplate.

Types B100 and E100 (with reference dial)

Controls are factory calibrated for maximum accuracy at the midpoint of the scale.

To re-calibrate, turn dial to desired set point (See Figure 2). If the actual temperature and set point temperature do not agree, turn hex adjustment screw towards the left (clockwise) to raise and towards the right (counter-clockwise) to lower temperature setting.

Types with Adjustable Deadband Switch (Option 1519)

Types with option code 1519 incorporate a snap switch with integral adjustment wheel. Turning this wheel raises or lowers the temperature rise set point. The fall set point remains constant. To use the adjustable deadband switch:

To increase deadband, turn the adjustment wheel left. This increases the rise set point while keeping the fall set point constant.

Consult UE for additional information.

Types with Manual Reset Button (Option 1530)

These optional models incorporate a snap switch that when actuated, remains actuated until the temperature decreases and the reset button (located on top of the control) is manually depressed to reset the switch.

C100, F100

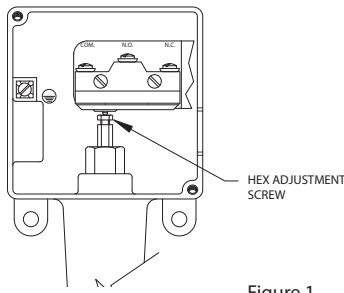

Figure 1

B100, E100

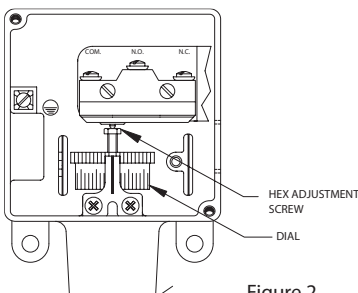
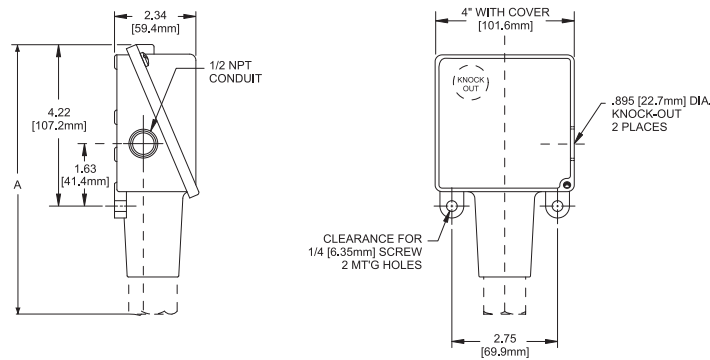

Figure 2

Dimensions

Dimensional drawings for all models may be found at www.ueonline.com.



Types B100, C100, E100, F100

Dimension A				
Type	Models	Inches	mm	Connection
B100, C100	120-121, 13546	9.38	238.3	Immersion Stem
E100, F100	1-8, 13545	8.69	220.7	Bulb & Capillary

Temperature Sensors

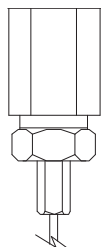

Bulb & Capillary
Models 1BC-8BC, 1BS-8BS, 13545

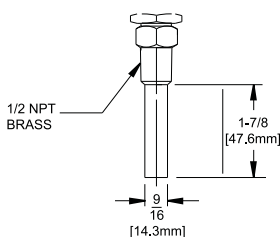

Immersion Stem
Models 120-121, 13546

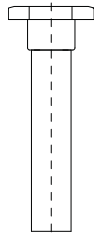

Immersion Stem
13546

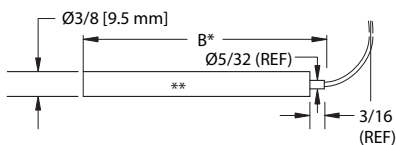

* USE DIMENSION "B" FOR SEPERABLE WELL INSTALLATIONS.

Remote Bulb

**Except model 13545. Bulb OD is Ø1/8 (3.3 mm)

Dimension B		
Model	Inches	mm
1BC/BS	3.75	95.3
2BC/BS/ BCA/BCB/ BSA/BSB	2.60	66.0
3BC/BS	2.13	54.1
4BC/BS	6.75	171.5
5BC/BS	5.00	127.0
6BC/BS	4.50	114.3
7BC/BS	3.00	76.2
8BC/BS	3.25	82.6
13545	11.63	295.4

RECOMMENDED PRACTICES AND WARNINGS

United Electric Controls Company recommends careful consideration of the following factors when specifying and installing UE pressure and temperature units. Before installing a unit, the Installation and Maintenance instructions provided with unit must be read and understood.

- To avoid damaging unit, proof pressure and maximum temperature limits stated in literature and on nameplates must never be exceeded, even by surges in the system. Operation of the unit up to maximum pressure or temperature is acceptable on a limited basis (e.g., start-up, testing) but continuous operation must be restricted to the designated adjustable range. Excessive cycling at maximum pressure or temperature limits could reduce sensor life.
- A back-up unit is necessary for applications where damage to a primary unit could endanger life, limb or property. A high or low limit switch is necessary for applications where a dangerous runaway condition could result.
- The adjustable range must be selected so that incorrect, inadvertent or malicious setting at any range point cannot result in an unsafe system condition.
- Install unit where shock, vibration and ambient temperature fluctuations will not damage unit or affect operation. When applicable, orient unit so that moisture does not enter the enclosure via the electrical connection. When appropriate, this entry point should be sealed to prevent moisture entry.
- Unit must not be altered or modified after shipment. Consult UE if modification is necessary.
- Monitor operation to observe warning signs of possible damage to unit, such as drift in set point or faulty display. Check unit immediately.
- Preventative maintenance and periodic testing is necessary for critical applications where damage could endanger property or personnel.
- Electrical ratings stated in literature and on nameplate must not be exceeded. Overload on a switch can cause damage, even on the first cycle. Wire unit according to local and national electrical codes, using wire size recommended in installation sheet.
- Do not mount unit in ambient temp. exceeding published limits.

LIMITED WARRANTY

Seller warrants that the product hereby purchased is, upon delivery, free from defects in material and workmanship and that any such product which is found to be defective in such workmanship or material will be repaired or replaced by Seller (Ex-works, Factory, Watertown, Massachusetts. INCOTERMS); provided, however, that this warranty applies only to equipment found to be so defective within a period of 24 months from the date of manufacture by the Seller. Seller shall not be obligated under this warranty for alleged defects which examination discloses are due to tampering, misuse, neglect, improper storage, and in any case where products are disassembled by anyone other than authorized Seller's representatives. EXCEPT FOR THE LIMITED WARRANTY OF REPAIR AND REPLACEMENT STATED ABOVE, SELLER DISCLAIMS ALL WARRANTIES WHATSOEVER WITH RESPECT TO THE PRODUCT, INCLUDING ALL IMPLIED WARRANTIES OF MERCHANTABILITY OR FITNESS FOR ANY PARTICULAR PURPOSE.

LIMITATION OF SELLER'S LIABILITY

SELLER'S LIABILITY TO BUYER FOR ANY LOSS OR CLAIM, INCLUDING LIABILITY INCURRED IN CONNECTION WITH (I) BREACH OF ANY WARRANTY WHATSOEVER, EXPRESSED OR IMPLIED, (II) A BREACH OF CONTRACT, (III) A NEGLIGENT ACT OR ACTS (OR NEGLIGENT FAILURE TO ACT) COMMITTED BY SELLER, OR (IV) AN ACT FOR WHICH STRICT LIABILITY WILL BE INPUTTED TO SELLER, IS LIMITED TO THE "LIMITED WARRANTY" OF REPAIR AND/OR REPLACEMENT AS SO STATED IN OUR WARRANTY OF PRODUCT. IN NO EVENT SHALL THE SELLER BE LIABLE FOR ANY SPECIAL, INDIRECT, CONSEQUENTIAL OR OTHER DAMAGES OF A LIKE GENERAL NATURE, INCLUDING, WITHOUT LIMITATION, LOSS OF PROFITS OR PRODUCTION, OR LOSS OR EXPENSES OF ANY NATURE INCURRED BY THE BUYER OR ANY THIRD PARTY.

UE specifications subject to change without notice.



UNITED ELECTRIC CONTROLS

P.O. Box 9143, Watertown, MA 02471-9143 USA

617 926-1000 Fax 617 926-2568

<http://www.ueonline.com>