

Installation Instructions

Commercial Heating Cable Products



PJ970
May 2021

Table of Contents

Important Safeguards and Warnings	3
System Components	4
Chromalox Cable Types	5
General Information	6
Use of Manual	6
Storage.....	6
Important Installation Notes	6
Installation	7
Pre-Installation Guidelines	7
Installation Guide: Single Run of Cable.....	8
Installation Guide: Multiple Cable Runs	9
Installation on Fire Protection Systems.....	10
Other Installation Considerations.....	11
Typical Installation Details	12
Wiring	16
Heating Cable Components	17
Connection Kits.....	17
Accessories.....	18
Control Systems	19
Controllers.....	20
Thermal Insulation	23
Commission Testing	23
Specifications	24
Troubleshooting	26
Locating Faults.....	27
Insulation Resistance (Megger) Test.....	29
Stabilized Current Test	29
End of Current Voltage Test.....	29
Installation and Maintenance Log	31

Important Safeguards and Warnings

⚠ WARNING

FIRE HAZARD. Failure to follow these guidelines could result in property damage or personal injury.

- **Disconnect all power sources before installing or servicing heating cable. Failure to do so could result in personal injury or property damage.**
- **Heating cable must be installed by a qualified person in accordance with the National Electrical Code, NFPA 70.**
- **Each heating cable branch circuit must be effectively grounded in accordance with the National Electrical Code to eliminate shock hazard.**
- **Never attempt to use damaged heating cables or connection kits. If cable damage is observed, either replace the complete heating cable, or cut out the damaged section and replace using the proper splice connection kit. Do not attempt to repair damaged heating cable.**
- **Never energize the cable when it is coiled or on a reel. Test only when it is laid out straight.**
- **Handle coils and reels utilizing equipment designed for that purpose.**
- **Do not drop coils or reels, especially from transporting equipment.**
- **Lift or handle reels so that the lifting/handling device does not come in contact with the cable or it's protective covering. Coils should be placed on a skid.**
- **Handle reels so that the deterioration or physical damage of cable is prevented.**
- **Do not install heating cable on equipment which could become hotter than the heating cable's maximum exposure temperature.**
- **Do not install heating cable in an area or on equipment which contains potentially corrosive materials without having a suitable protective jacket on the cable. Observe all published specifications.**
- **Do not expose cables to temperatures above their specified maximums. Do not run cables longer than specified maximum circuit lengths. See tables provided in this installation manual for details.**

- **Never use tie-wire or pipe straps to secure Self-regulating or Constant Wattage heating cables, as this may damage the cable.**
- **Keep bus wires separated to avoid shorting the cable.**
- **Keep cable ends and connection kits dry before and during installation.**
- **Be careful not to break bus wire strands when preparing the cable, as damaged bus wires can overheat and short.**
- **The presence of heating devices must be evident by the posting of caution signs or markings at appropriate locations and/or at frequent intervals along the circuit.**
- **Users should install adequate controls and safety devices with their electric heating equipment. Where the consequences of failure may be severe, back-up controls are essential. Although the safety of the installation is responsibility of the user, Chromalox will be glad to assist in making equipment recommendations**
- **Insulate the pipe immediately after installing the heating cable, using only fire-resistant insulation materials.**
- **Ground fault equipment protection is required for each circuit.**
- **Heating cables require a Class A ground-fault circuit-interrupter and any metallic components in contact with the heating device shall be bonded to ground.**
- **The earthing braid of the heat trace cable must be bonded to a suitable earth terminal.**

⚠ CAUTION

A ground fault protection device must be used with this heating device.

⚠ ATTENTION

Ce produit doit être utilisé avec une protection de mise à la terre

System Components

A complete electric heat trace system includes the following system components – See the figure below for a typical system.

1. Electric Heat Tracing (Self-regulating, Constant Wattage)
2. Termination Accessories
 - A. Power Connection
 - B. Splice/Tee
 - C. End Seal (under insulation, above insulation or signal light type)
 - D. Control Thermostat or RTD Sensor
 - E. Attachments
 - i. Fiberglass tape
 - ii. Aluminum tape for plastic pipe install
 - iii. Pipe clamps for termination accessories
 - iv. Electric Trace Caution Label
3. Controls
 - A. Thermostats
 - B. Digital Thermostats
 - C. Single/Dual Loop Panels
 - D. Weather Trace Panels
 - E. IntelliTrace Panels
4. Thermal Insulation
5. Weather Barrier for Insulation

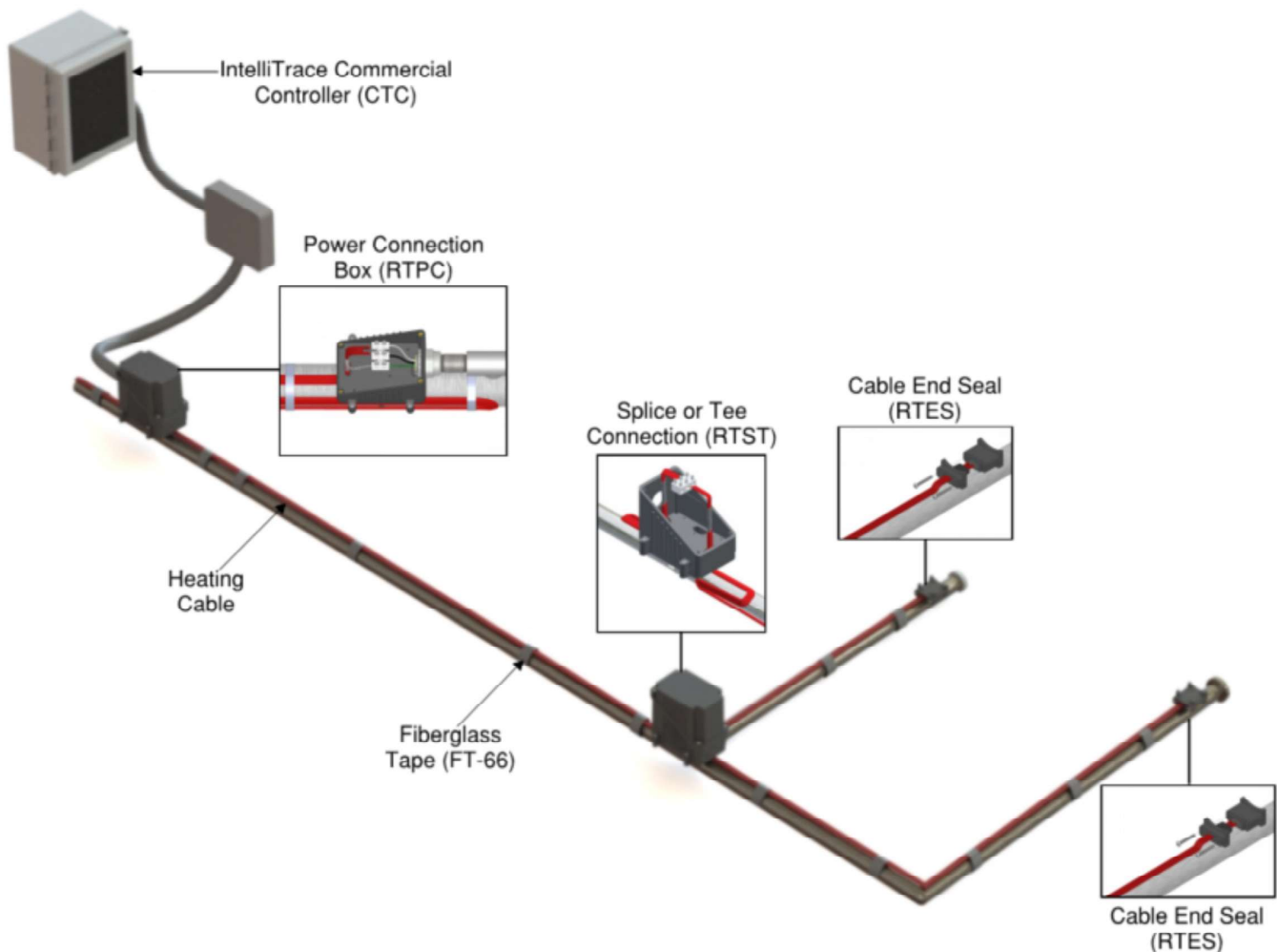

Chromalox Cable Types

Table 1 – Cable Type Overview

	CPR	CPM	CZH	HWM*
Hazardous ratings available	Yes	Yes	Yes	No
Usable on plastic pipe	Yes	No	No	No
Can be cut to length in field	Yes	Yes	Yes**	Yes
Can be single overlapped	Yes	Yes	No	Yes

* HWM is only FM approved.

** Must be cut at module point to avoid cold leads.

Table 2 – Maximum Temperatures

Cable Type	Max Maintain (Power On)	Max. Exposure (Power Off)	Voltage Rating
CPR	150°F	185°F	120, 208-277
CPM	302°F	420°F	120, 208-277
CZH	320°F*	392°F	120, 208-277, 480
HWM	140°F	275°F	120, 208-277

* See Table 13 for maximum maintenance temperatures at each output.

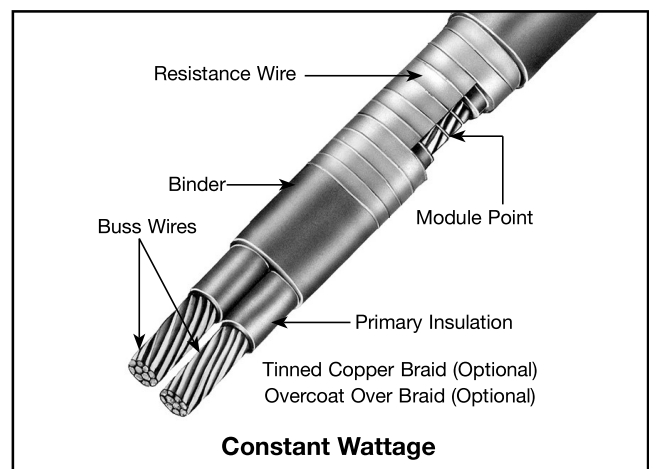
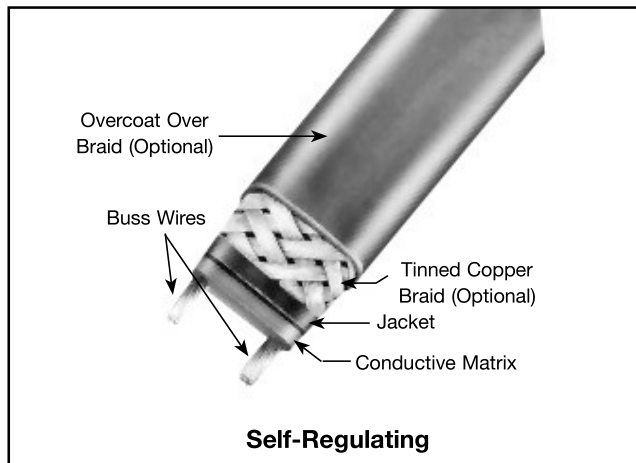

Approvals

Chromalox heating cables and components approved for use in hazardous and nonhazardous locations. Refer to the specific product data sheets for details.

General Information

Use of Manual

These instructions are to be followed when installing Chromalox heating cables on pipes in ordinary locations. Consult factory for installation of braided cable in hazardous locations. This manual discusses the installation of two types of heating cables: Self-Regulating and Constant Wattage. Although they are both resistance type cables, they have different operating characteristics. These characteristics may make one type of cable more suitable for a particular application than another. This manual, however, is not intended as a product selection manual. Refer to appropriate application design guide for product selection guidelines. A chart highlighting certain characteristics for Chromalox heating cables can be found on page 5.

For customer support, design assistance, or information regarding any other Chromalox products, please contact your local Chromalox representative or use the information below.

Chromalox, Inc.
103 Gamma Drive
Pittsburgh, PA 15238
Tel: +1 (412) 967-3800
Fax: +1 (412) 967-5148
Email: is@chromalox.com
www.chromalox.com

Storage

The heating cables should be stored in their shipping cartons or on reels in a dry atmosphere until they are ready to be installed. They should be stored in a clean location, where they are protected from mechanical damage.

Storage temperature range: 0°F(-18°C) to 140°F(60°C).

Important Installation Notes

The following notes should be reviewed prior to installation.

- Always install tracing at the 4 or 8 o'clock position on a pipe.
- Do not attempt to heat trace any piece of equipment which will not be insulated.
- Allow a minimum of 2" between cable runs.
- Always install heat tracing on the outside radius of elbows.
- Never install heat tracing over expansion joints without leaving slack in the cable.
- Pumps and small vessels should be heat traced and controlled with the piping on the inflow end. The cable on the pump or vessel should be physically separate to permit disconnection during maintenance or removal.
- Use aluminum foil tape to cover the heating cable whenever the cable is not in good contact with the pipe (i.e. at supports, valves, pumps, etc.).
- Separately controlled circuits should be provided on dead end legs and closed bypasses.
- No heat tracing circuit should extend more than two feet beyond a point where two or more pipes join when such junctions permit optional flow paths. In such cases, separately controlled traces should be used.
- The minimum installation temperature for all Chromalox heating cables is -40°F (-40°C).
- Chromalox Type CPR heating cables are well suited for heat tracing plastic pipes. Consult "Chromalox Design Guide for Heat Tracing Products" for design recommendations. Installation details AD1 through AD17 apply for plastic pipe only when Type CPR heating cable is used. Consult factory for applications involving other products.
- Always ensure that the heating cable load is compatible with the rating of the selected control systems.
- Only install control devices where the electrical conduit has a low-point drain that prevents condensation from entering the thermostat enclosure.

NOTICE

STORE IN DRY AREA



These products may become damaged by moisture. Damage to electrical components, electrical properties, corrosion or other damage may occur if equipment is not stored in a dry location. Visual inspection and electrical checks must be performed prior to installation to ensure safety and proper operation. See equipment installation manual or contact the factory for more information. 800-443-2640 or www.chromalox.com.

Installation

Pre-Installation Guidelines

Before attempting to install the heating cable, read this instruction sheet and those enclosed with the accessories to familiarize yourself with the products. Complete the following pre-installation steps:

- Verify that the selection of heating cable type and rating is in accordance with the procedures located in the applicable application design guide.
- Ensure that the voltage rating of the heating cable is acceptable for the available service voltage.
- Walk along the pipe segment that is to be traced and plan out the path for the heating cable on the pipe.
- Remove any obstacles or sharp edges that are present along the pipe segment.
- Open package and visually check for breaks or nicks in the cable jacket. File claim with carrier if any damage is found.
- After removing the cable from the carton or wrapping, measure the insulation resistance of the unit from buss wires to braid at 2,500 Vdc. to assure the cables have not been damaged during shipping and handling. If the cable has no braid, uncoil the cable onto a metal surface and check resistance between the buss wires and the metal surface. See Table 5 for acceptable minimum insulation resistance readings for a detailed explanation on how to conduct the insulation resistance test.

⚠ WARNING

ELECTRIC SHOCK HAZARD. Any cable with an insulation resistance reading less than 20 megohms before installation should not be installed. Contact your local Chromalox representative.

- Ensure all pipes, tanks etc. have been hydrostatically tested prior to the installation of the heating cable.
- Ensure all cable ends, connections, and surfaces are dry prior to installation.

⚠ WARNING

ELECTRIC SHOCK HAZARD. Disconnect all power before installing or servicing heating cable. Failure to do so could result in personal injury or property damage. Heaters must be installed by a qualified person in accordance with IEC 62086-2:2001.

Any installation involving electric heating must be effectively grounded in accordance with IEC 62086-2:2001 to eliminate shock hazard.

Installation Guide: Single Run of Cable

If installing a single run of heating cable on a pipe, follow the steps below:

1. Mount the reel of cable on a holder and place near one end of the pipe run to be traced. Choose the end from which it will be the easiest to pay out the cable.
2. Pay out the cable from the reel and loosely string along the piping, making sure the cable is always next to the pipe when crossing obstacles. For example, if the heater is on the wrong side of a crossing pipe, you will have to restring the cable or cut and splice it.

CAUTION

To prevent damage to cable, avoid such things as:

- **Pulling the cable over sharp edges.**
- **Forcibly pulling the cable free if it snags while being paid out.**
- **Walking on or subjecting the cable to other abuse which could cause mechanical damage.**

3. When you reach the end of the circuit, secure the heating cable to the pipe using glass tape or plastic cable tie with a temperature rating compatible with the heater cable.
If this end is to have an end seal installed, remember to leave about a foot of extra cable. If it is a power connection, leave about two feet of extra heater cable.
4. If the heater cable is to be spiraled, go to step 4a.
Begin attaching the cable to the pipe about every foot (0.3 meters).
Place the cable on the bottom half of the pipe at the 4 or 8 o'clock position. Refer to installation detail AD1. Go to step 5.
 - a. Note the path of the heater cable and the spiral factor of the design. A simple way to think about spiral factor is: A 1.1 spiral factor means install 11 feet of heating cable on every 10 feet of pipe, etc. At about every 10 feet of pipe, pull the required amount of cable and let hang in a loop, and attach the cable to the pipe.
 - b. Rotate the loops around the pipe until all the slack has been taken up. Even out the spirals of the heater cable and secure to the pipe as necessary to obtain good contact. The entire circuit can be installed with hanging loops with the spiraling on the pipe being done when you trace the heat sinks. Refer to installation detail AD3.

5. At a heat sink (pipe supports, valves, pumps, reducers, gauges, bucket strainers, etc.), attach the heater cable to the pipe just before the heat sink. Refer to the design specs or Table 3 to determine the amount of heater cable you need to install on the heat sink. Pull this amount of cable into a loop, attach the heater cable on the other side of the heat sink and continue attaching the cable down the pipe as before.
6. When you reach the heater cable reel, you should have the heater cable attached all along the pipe, with the correct amount of heater cable pulled in loops at all heat sinks. Attach the cable to the pipe, (leave an extra foot if at an end seal, two feet if at a power connection) and cut the heater cable from the reel.
7. Install the heater cable loops on the heat sinks. Refer to the proper installation detail AD5-AD12 for a general idea of how to install the cable, but remember:
 - It is important to get the proper amount of heater cable on the heat sink, rather than exactly as the detail shows. The detail is just a guide.
 - Self-regulating heater cables are very flexible and can be single overlapped for installation ease. Feel free to use this feature when you can.
 - By having the cable installed this way, it can be removed easily from the heat sink without cutting of access to, or removal of the heat sink is required.

Note: If a tee is designed into the system, or if you are using two or more short cable lengths to complete a circuit, allow two or three feet of each cable to overlap. This will allow flexibility in assembling the connection kit and locating it on the pipe.

WARNING

FIRE HAZARD. Do not overlap constant wattage heating cables.

Installation Guide: Multiple Cable Runs

There are two cases where you will need to install more than one heater cable on a pipe:

- When the design calls for more than one cable.
- When the lines being heat traced are considered important enough to install a backup (redundant) heat tracing system.

The installation requirements are different for these cases.

Installing Multiple Heater Cables for Design Requirement

The most common multiple cable requirement is two cables on a pipe. Below are the recommended techniques for the two cable systems. They also apply to installations where three or more cables are to be installed on a pipe.

There are two ways of paying out two heater cables along a pipe. The first is to locate two reels of heater cable and supply one cable from each. This method works for all types of piping runs. However, it may increase material waste by leaving unusable lengths from two reels. The second way is to supply both cables from one reel. This method is generally the easiest for relatively straight, simple piping runs. For each circuit, decide which method to use and then go to the appropriate part below.

1. Supplying cable from two reels

The general procedure here is the same as given earlier, but there are a few things to do to make sure the system is correctly done.

- a. At each heat sink, the easiest thing to do is supply the extra heater called for by the design drawing from only one heater cable. This avoids having to measure out half of the requirement from each cable.
- b. When doing the previous step, leave a small loop in the other cable at equipment which may be serviced, such as pumps, valves, instruments, etc. This is so both heater cables may be removed enough for future access.

2. Supplying cable from one reel

The general procedure is the same as given earlier, but there are a few things to do to make sure the system is correctly done.

- a. With this method, a loop is pulled for the entire circuit. To do this, attach the end of the heater cable to the pipe near the heater cable reel. Remember to leave enough extra cable for the type of connection to be installed.

- b. Begin pulling the cable off the reel in a large loop down the piping run. Be sure to keep the cable next to the pipe. Moving down the run, continue attaching the cable to the pipe, leaving the side of the loop going back to the reel unattached.
- c. You will want both sides of the loop to be about the same length to avoid future problems. Also, it is easier to install the extra cable required at each heat sink from only one cable. Therefore, pull the right amount of extra heater cable needed at every second heat sink from the side of the loop you are attaching to the pipe. At the remaining serviceable heat sinks (pumps, valves, instruments, etc.) do not forget to leave a short loop of cable for slack when access to the equipment is needed.
- d. When the end of the piping run is reached, pull the proper amount of extra cable for the connection to be installed.
- e. Now, begin working the remaining side of the loop back toward the reel, installing it on the pipe and heat sinks as required.

Installing Backup (Redundant) Systems

The purpose of a backup system is to provide the proper amount of heat from the second heater cable if there are problems with the first. Therefore, each cable must be installed so it can do the job alone. The simplest way to do this is to install the first heater cable as described in the *Installation Guide: Single Run of Cable* section. Then, go back and install the backup heater cable the same way.

There are several things to keep in mind:

- The power connections and end seals for the two cables are often designed to be at opposite ends of the run in a redundant system. Remember to leave the proper amount of extra cable for the connection to be installed on each cable at that end.
- On piping one inch IPS or smaller, it can be difficult to apply both heater cables with good contact at all places. The main thing is to get the correct amount of cable installed. However, try to get as much contact with the piping and heat sinks from both cables as possible.

Installation on Fire Protection Systems

The Chromalox CPR heating cable can be used on the following fire protection systems:

- Insulated UL listed steel schedules 5, 10, 20, and 40 standpipe and sprinkler system pipe up to and including 6 in. size. Includes use on elbows, tees, flanges, hangers, and valves. **NOTE:** UL listed fiberglass insulation with a minimum k-factor of 0.25 BTU/hr-°F/ft²-in with weather-proof cladding must be used.
- Systems having piping which connects between buildings in unheated areas, coolers, and freezers.
- Systems having sprinkler piping that is installed in coolers/freezers where the temperature is -40°F or greater.
- Sprinkler heads with a temperature rating of 155°F (68°C).

NOTE: Not intended to be used as the means to prevent freezing of sprinkler branch lines including all accessories for these lines and automatic (deluge, preaction, dry pipe, alarm, etc.) valves as referenced in NFPA 13.

For use in Ordinary Hazard Occupancies only as specified in NFPA 13, the standard for the installation of sprinkler systems.

The design and monitoring of pipe freeze protection systems for fire sprinklers must be in accordance with IEE 515.1. When installing fire sprinkler pipe freeze protection, the below guidelines should be followed:

- One RTBC power connection/thermostat is required per circuit for overtemperature protection.

- A controller can protect multiple segments using an ambient temperature sensor.
- The heat trace controller must be permanently connected to the power supply.
- If backup power is provided for the building electrical systems, it should also provide backup power for the pipe freeze protection systems.
- A set of dry contacts should be provided to connect the heat trace controller to the fire alarm control panel.
- Local audible and visual alarms and a supervisory signal to the fire alarm control panel should be provided for each or the following conditions:
 - o Ground fault
 - o Low fire sprinkler pipe temperature
 - o High fire sprinkler pipe temperature
 - o Temperature sensor failure
 - o Controller failure
 - o Loss of continuity
 - o Loss of supply voltage
- Sprinkler systems with heat tracing should be properly grounded.

For proper installation of heating cables on fire sprinklers, see installation details AD18-AD20. Note that the installation details are examples of various fire sprinkler piping installation and are for reference only. Refer to Table 4 for additional heating cable length requirements for fire sprinklers.

Other Installation Considerations

Pipe Hanger

When using a pipe hanger, ensure that the heating cable is not pinched between the pipe and the hanger. Damage to the cable can result in electrical arcing, arc faults, and arc flashes.

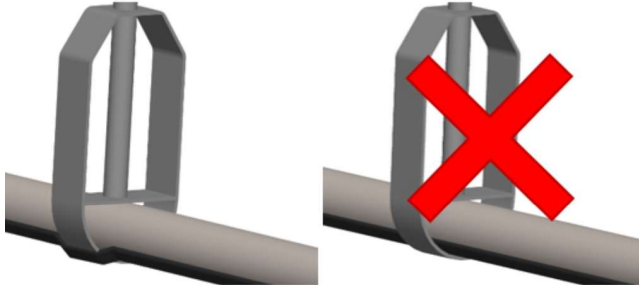

Bending the Heating Cable

Do not attempt to bend the heating cable in the flat plane, as it may be damaged. The minimum bending radius for all Chromalox heating cables is six times the minor diameter.



Heat Sinks

Refer to the design specs or Table 3 to determine the amount of heater cable you need to install on each heat sink. Install the heater cable on the heat sinks as explained in installation details AD5-AD12. However, remember that the detail is just a guide. It is important to get the proper amount of heater cable on the heat sink, rather than exactly as the detail shows.

Slab Penetrations

Before installing heating cables on a pipe that penetrates a concrete floor or wall, be sure that the hole comfortably fits both the pipe, cable, and insulation. Do not damage or cut the heating cable during installation. Make sure that the cable is not pinched between the pipe and the concrete floor and wall when the hole is sealed. When fire stopping around floor and wall penetrations, avoid damaging or cutting the heating cable. The heating cable should be protected by a tube or conduit and should not be installed directly into the sealing material.

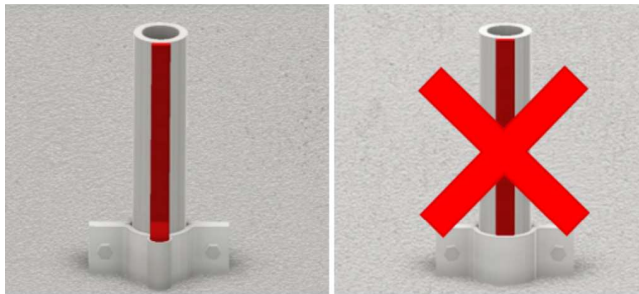

Table 3 – Additional Cable Lengths Required for In-Line Components (Based on Iron Pipe Size)

Piping Size	Gate Valve	Globe Valve	Ball Valve	Butterfly Valve	Shoe Support	Hanger Support	Sleeper Support	Flange Pair
Dimensions in Feet (Ft.)								
1/2 in.	1.00	1.00	1.00	1.00	1.00	1.00	1.00	0.30
3/4 in.	1.50	1.00	1.00	1.00	1.50	1.00	1.00	0.30
1 in.	2.00	1.00	1.00	1.00	1.50	1.00	1.00	0.30
1-1/2 in.	2.50	1.50	1.50	1.50	2.00	2.00	2.00	0.30
2 in.	2.50	2.00	2.00	2.00	2.00	2.00	2.00	0.30
2-1/2 in.	2.50	2.00	2.00	2.00	2.00	2.00	2.00	0.30
3 in.	3.00	2.50	2.50	2.50	2.00	2.00	2.00	0.50
4 in.	4.00	3.00	3.00	3.00	2.50	2.50	2.50	0.50
6 in.	5.00	3.50	3.50	3.50	2.50	2.50	2.50	0.80
8 in.	7.00	4.00	4.00	4.00	2.50	2.50	2.50	0.80
10 in.	8.00	4.50	4.50	4.50	3.00	3.00	3.00	0.80
12 in.	9.00	5.00	5.00	5.00	3.00	3.00	3.00	0.80
14 in.	10.00	5.50	5.50	5.50	3.00	3.00	3.00	1.00
16 in.	11.00	6.00	6.00	6.00	3.50	3.50	3.50	1.00
18 in.	12.00	7.00	7.00	7.00	3.50	3.50	3.50	1.00
20 in.	13.00	7.50	7.50	7.50	3.50	3.50	3.50	1.00
22 in.	13.00	7.50	7.50	7.50	3.50	3.50	3.50	1.00
24 in.	15.00	8.00	8.00	8.00	4.00	4.00	4.00	1.00

Table 4 – Additional Heating Cable Required for Fire Sprinkler Piping (Based on Iron Pipe Size)

Sprinkler Head without Sprig	Sprinkler Head with Sprig	Dry Sprinkler for Freezers
4X Pipe Diameter	2X Sprig Length	2X Drop Length
See AD18	See AD19	See AD20

Typical Installation Detail

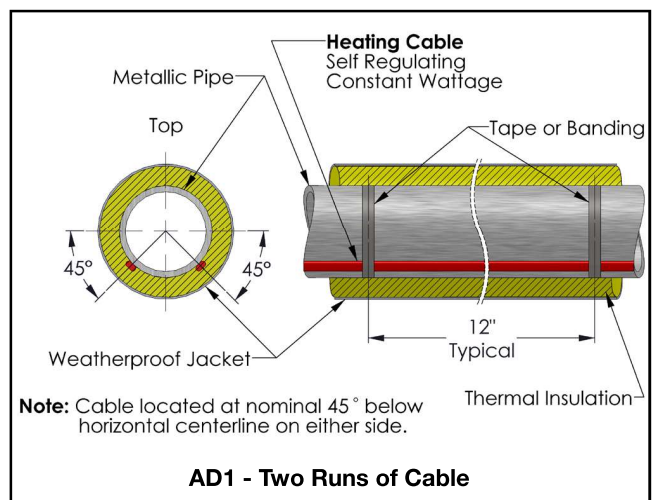
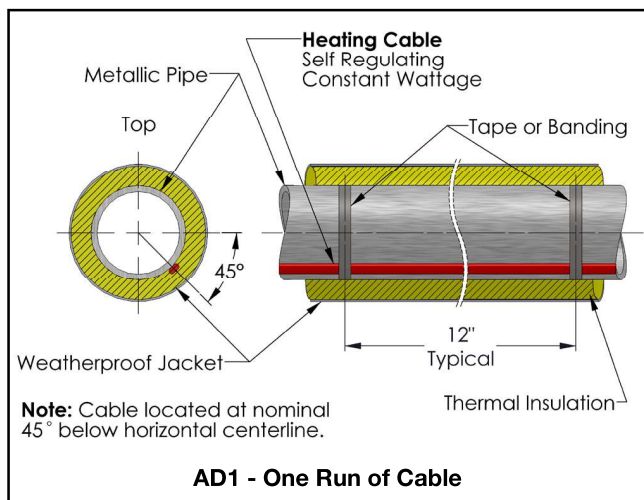

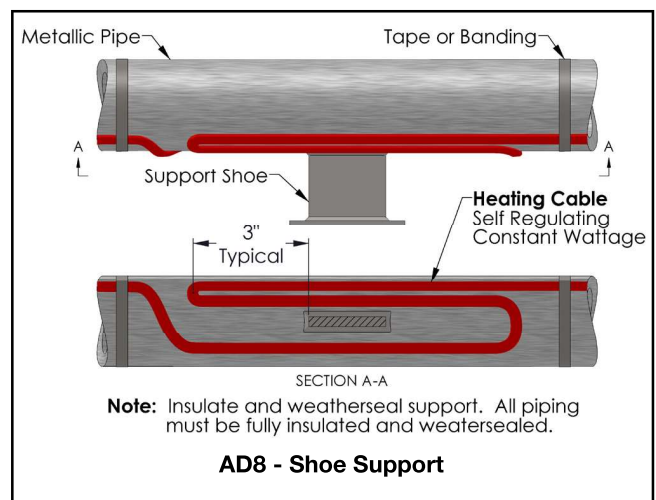
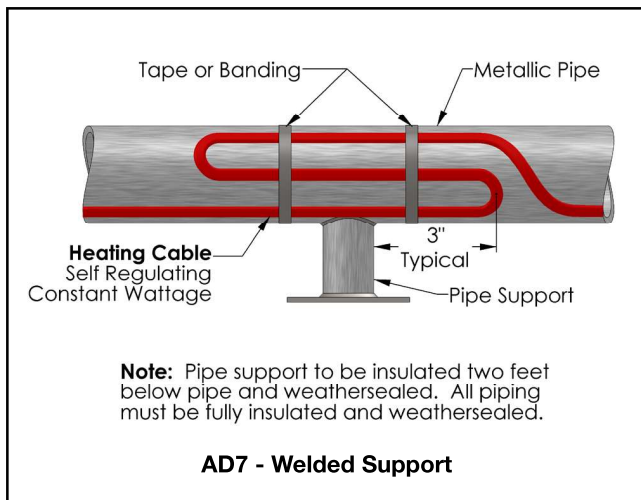
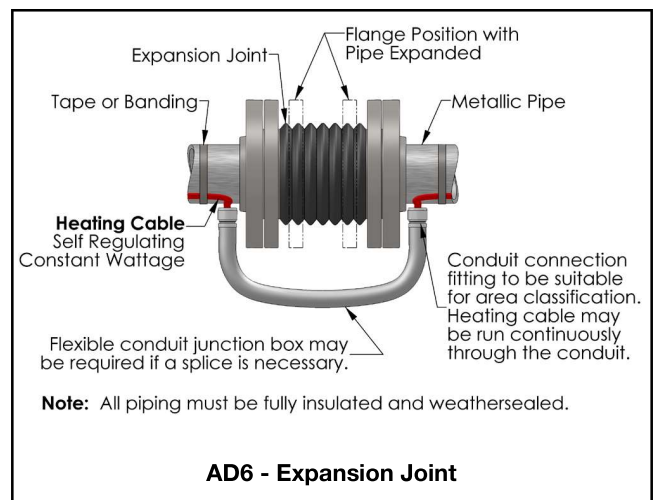
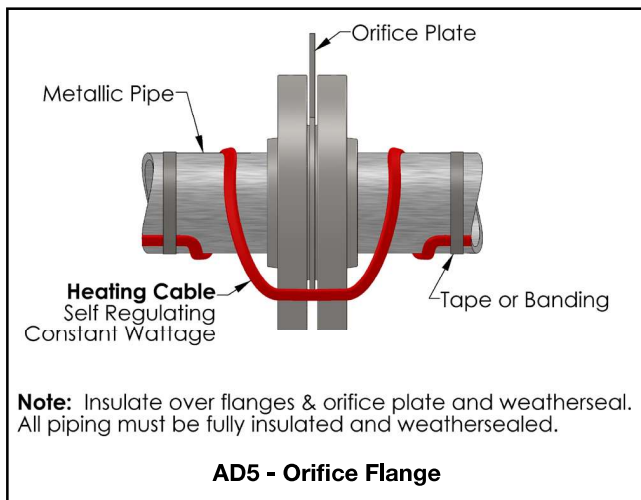
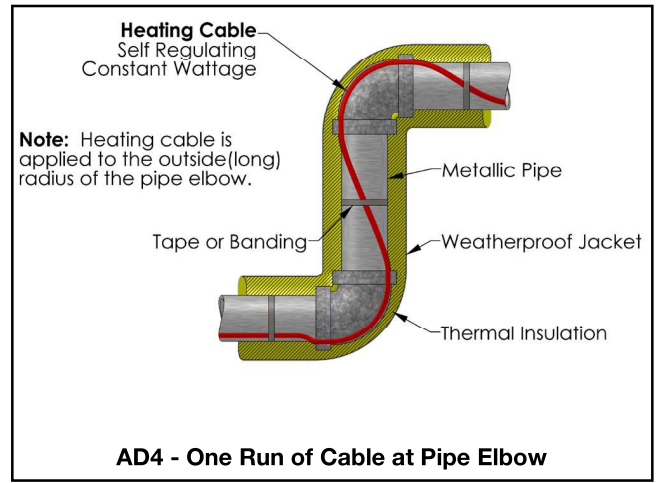
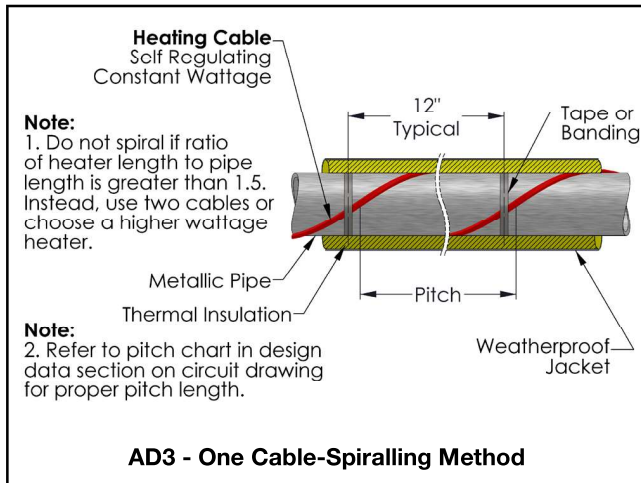

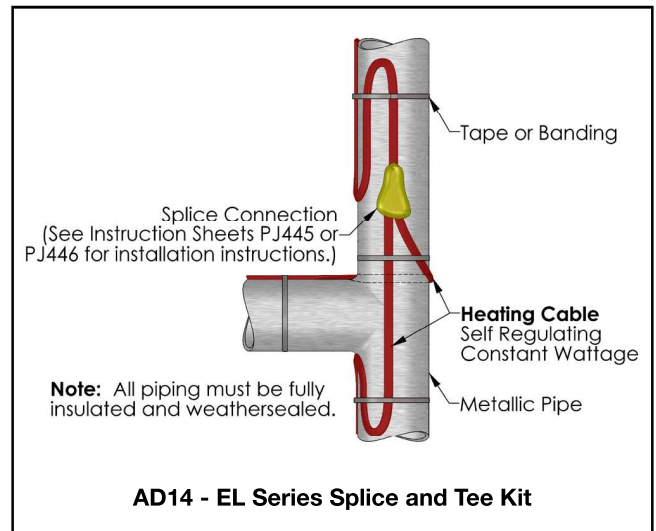
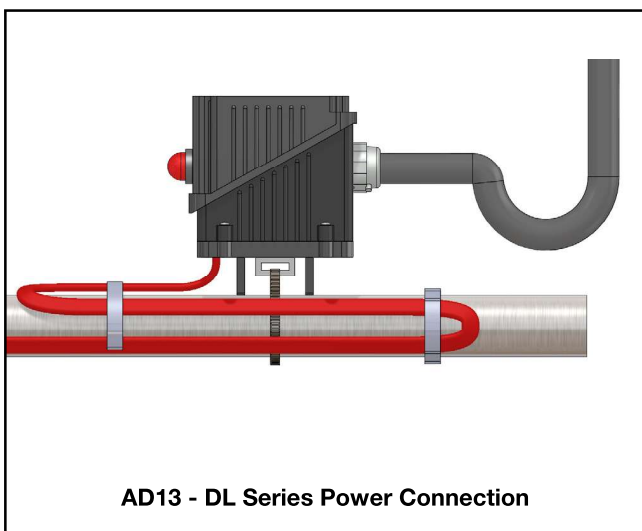
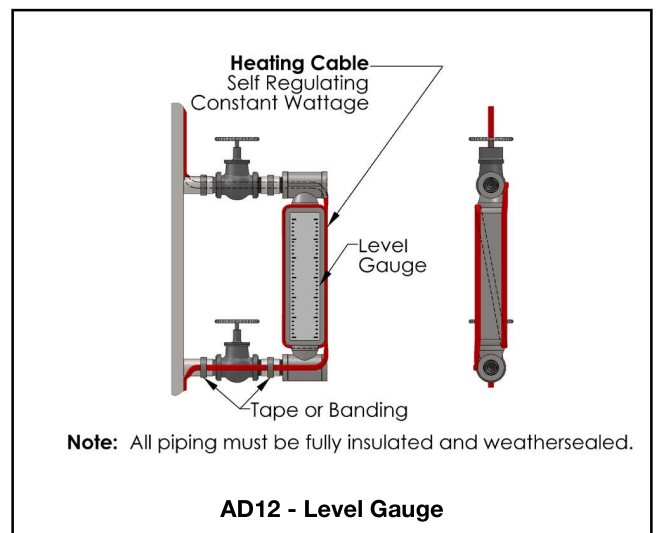
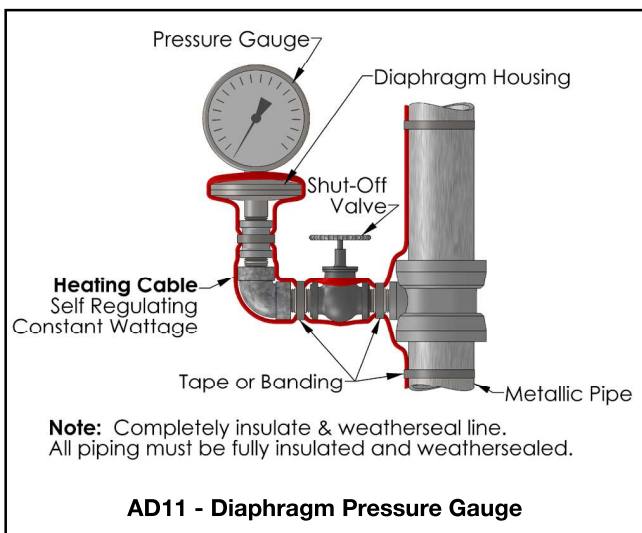
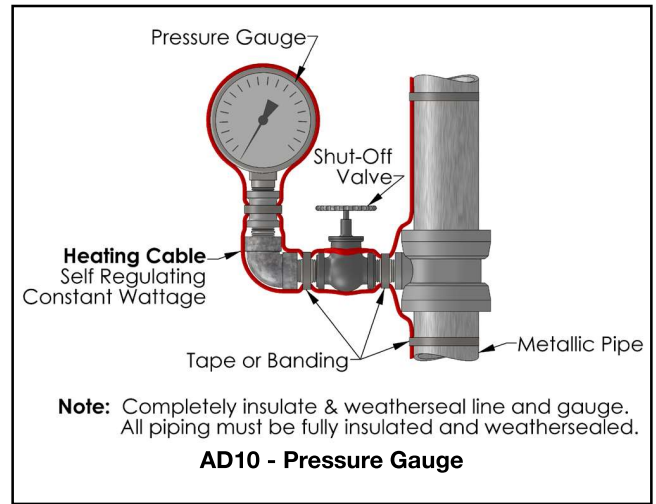
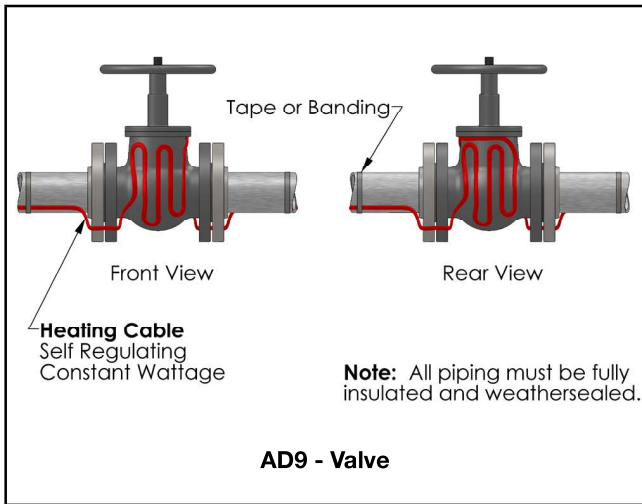

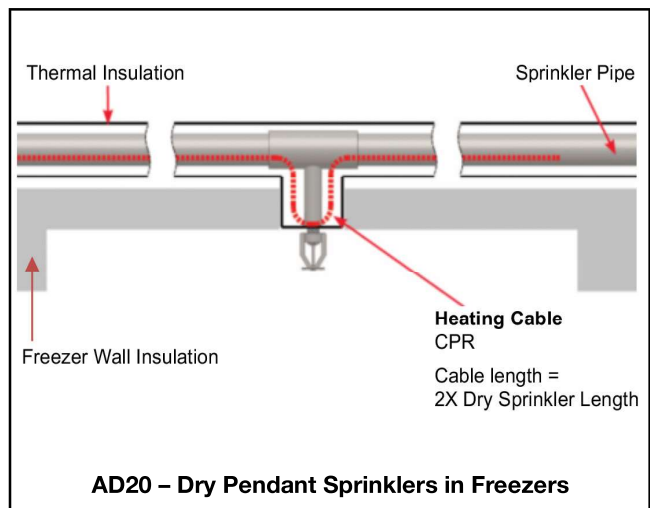
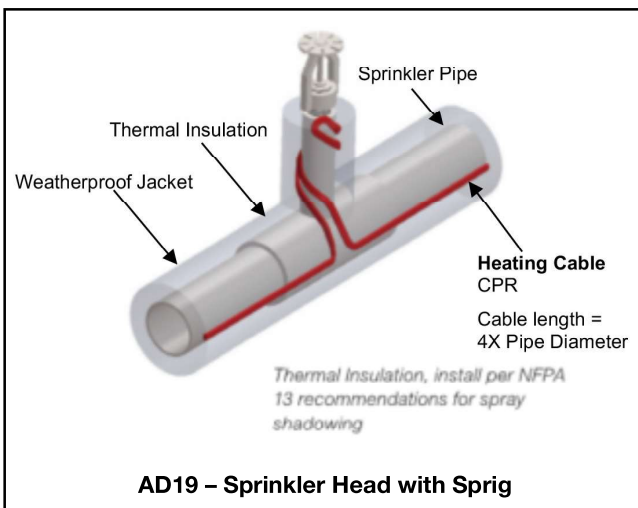
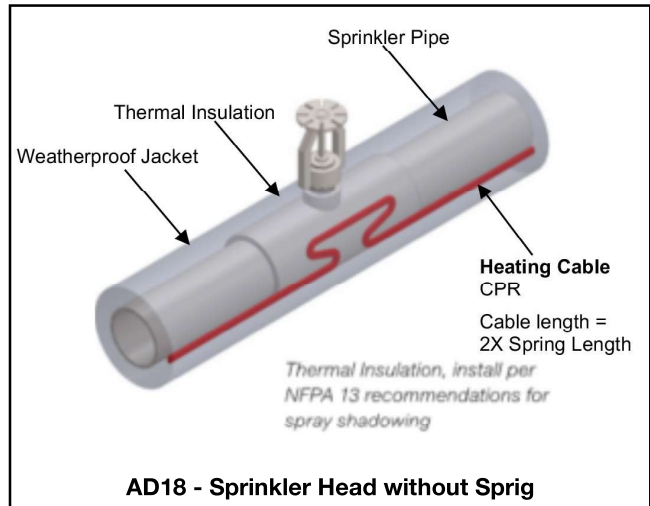
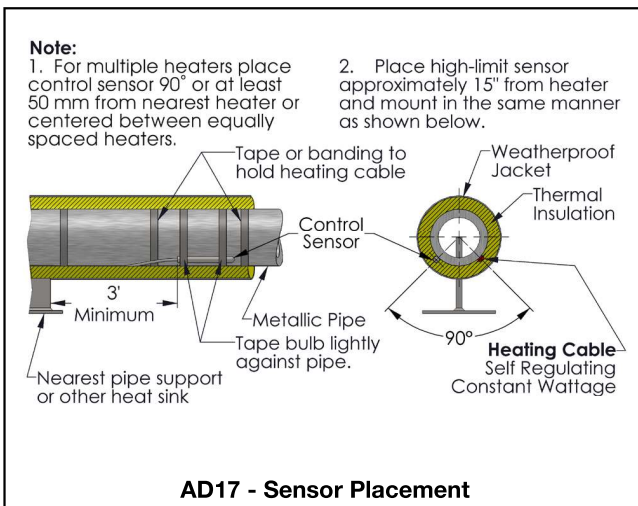
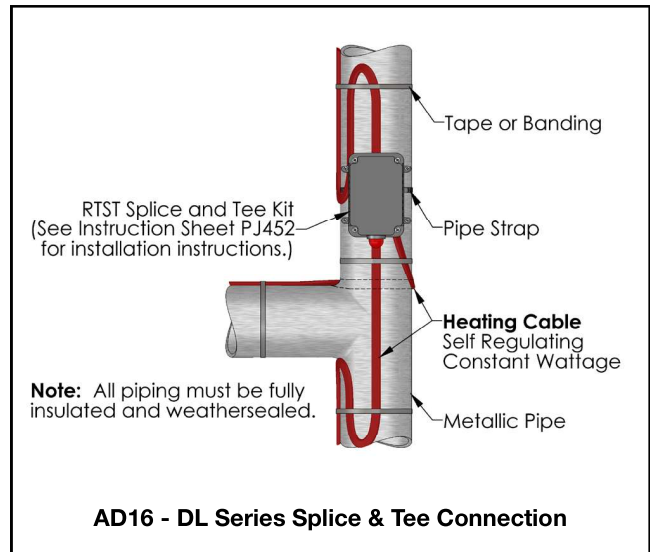
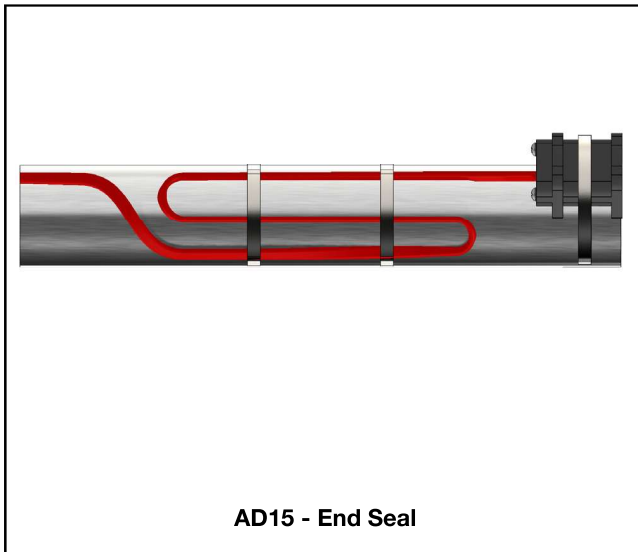

Wiring

⚠ WARNING

ELECTRIC SHOCK HAZARD. Disconnect all power before installing or servicing heating cable. Failure to do so could result in personal injury or property damage. Heater must be installed by a qualified person in accordance with the National Electrical Code, NFPA 70.

⚠ WARNING

ELECTRIC SHOCK HAZARD. Any installation involving electric heating cables must be performed by a qualified person and must be effectively grounded in accordance with the National Electrical Code to eliminate shock hazard.

ACCESSORIES:

- Selection of installation accessories should be in accordance with ChromaTrace for Buildings design software program. Ensure accessories are rated for the area where they are located. If Chromalox accessories are not used with cable, all third-party approvals are voided.
- Only use Chromalox installation kits and use them only for the operations for which they are designed.
- The instructions included in the Chromalox installation accessories must be followed for the third-party approvals (UL, FM, CSA, etc.) to apply.
- Junction boxes must be in accordance with the requirements of the area classification.
- All outdoor junction boxes must be located above grade level. Covers should be kept on the boxes at all time when not being worked in.
- All terminations must be protected from the weather and from physical damage by locating them either under the weather-proof insulation or inside an appropriate junction box.
- All equipment must be properly grounded.

- Install installation accessories according to the instructions included in the kits and per installation details AD13 through AD17.

⚠ CAUTION

To prevent equipment damage, Circuits fed from overhead lines should be protected by secondary lighting arrestors.

CONTROLS:

- All heating circuits should have temperature controls. Temperature control of the pipeline can be obtained through various Chromalox temperature controls.
- Contactors must be used when load currents exceed the rating of the thermostat contacts. Equipment protection ground fault (30 mA EPD) thermal breakers are recommended with types CPR, CPM, and GZH.
- The temperature control should be mounted in a location where it will not be subjected to excessive shock or vibration.
- Line sensing temperature sensors should be mounted in accordance with installation detail AD17.
- Ambient sensing temperature sensors should be located at a point where the lowest ambient temperature is expected.

⚠ CAUTION

To prevent equipment damage, handle and secure temperature sensors, especially thermostat bulbs and capillaries with care to avoid distortion or crimping which might impair control accuracy.

- Exposed thermostat capillaries should have mechanical protection.

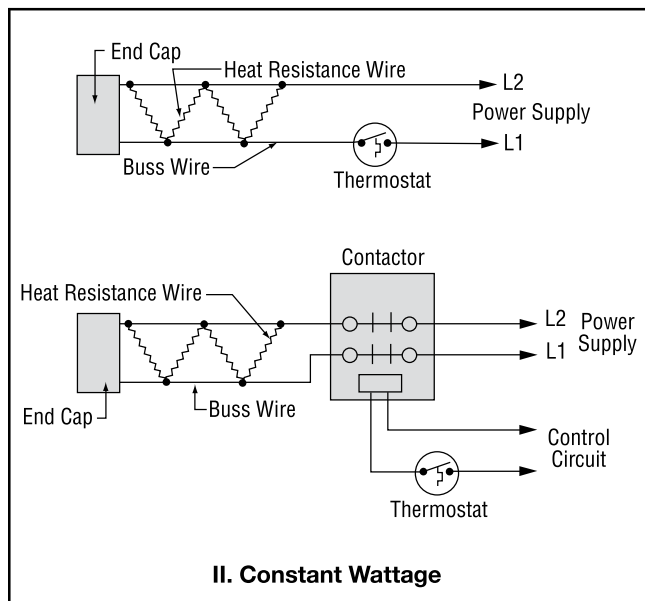
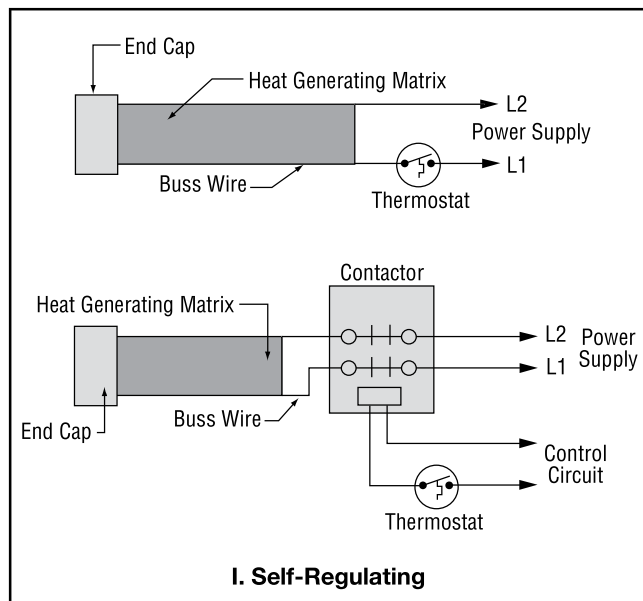

Installation Testing

To identify potential damage, installation testing should be completed at the following times:

- Prior to installing the heating cable
- Prior to installing the connection kits
- Prior to insulating the pipe
- After insulating the pipe
- Prior to energizing the cable
- During periodic system check-ups
- After maintenance/repair work

As part of the installation testing, complete the following steps:

1. Visually inspect the heater cable and temperature controls for signs of mechanical damage. If damage is seen, either replace the complete heater cable, or cut out the damaged section and replace using the proper splice connection for the area and cable you are using.
2. Inspect all connections to be sure they are correctly assembled. Be sure each heater cable entry to a connection has a grommet and the compression plates and caps are properly tightened.
3. Determine the insulation resistance of the circuit using at least 1,000 VDC. It is strongly recommended that higher test voltages be used. Polymeric cables (CPR, CPM, CZH) should be tested at 2,500 VDC. Always perform this test at the power connection. See Table 5 for minimum insulation resistance readings. Any cable with an insulation resistance below the recommended value should be removed and factory should be contacted. See page 27 for a detailed explanation on how to conduct the insulation resistance test.
4. Check voltage at the end of circuit and record in the log on page 28. See page 27 for information on how to complete the end of circuit voltage test.



Table 5 – Minimum Insulation Resistance Readings

	Delivery	Installation Pre-Insulation	Installation Post-Insulation	Maintenance
Chromalox CPR	20 MΩ	20 MΩ	5 MΩ	5 MΩ
Chromalox CPM	20 MΩ	20 MΩ	5 MΩ	5 MΩ
Chromalox CZH	20 MΩ	20 MΩ	5 MΩ	5 MΩ
Chromalox HWM	20 MΩ	20 MΩ	5 MΩ	5 MΩ

Heating Cable Components









Connection Kits

Table 6 – DL Series Connection Kits Overview

	Catalog Number	Description	Installation Manual
	RTES End Seal Kit	NEMA 4X rated enclosure that provides waterproof cable entry for one (1) cable. The fitting has two (2) different mounting surfaces: one for pipes with a diameter of 3" or more, and one for smaller pipes	PJ450
	RTPC Power Connection Kit	NEMA 4X rated junction box that provides waterproof cable entry for up to three (3) cables with an opening to accept a 3/4" conduit hub (Chromalox CCH-2 or equal). Signal light options also available. See installation manual PJ459	PJ451
	RTST Slice & Tee Kit	NEMA 4X rated junction box that provides waterproof cable entry for two (2) cables for a splice or three (3) cables for a tee.	PJ452



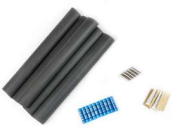

EL Series

Table 7 – EL Series Connection Kits Overview

	Catalog Number	Description	Instruction Manual
	RG-EK-1 End Seal Kit	Materials to make an end seal that terminates one (1) cable.	PJ480
	RG-PK-1 Power Connection Kit	Kit that provides power termination for a junction box. Contains one (1) end seal and two (2) warning labels.	PJ478
	RG-SK-1 Splice Kit	Materials to make one (1) splice connection. The connection kit has a weatherproof sleeve to ensure trouble-free operation.	PJ479
	RG-STK-1 Splice & Tee Kit for Self-Regulating Cable	Materials to make one (1) splice or tee connection. The connection kit has a weatherproof sleeve to ensure trouble-free operation.	PJ940
	PJB Rain Tight Junction Box	Polycarbonate watertight enclosure that protects the contents from rain when using the SSK Junction Box Connection Kit.	N/A
	RT-TST End Seal Kit for CWM	Materials to make five (5) splice and tee connections for constant wattage cables.	PJ446
	RT-RES End Seal Kit	Set of five (5) heat shrink caps for use with CPR-CR and CPR-CT cables.	PJ441
	RT-RST Splice & Tee Kit for Self-Regulating Cable	Materials to make five (5) splice and tee connections for CPR-CR, HWM-CT, and CPR-CT cables.	PJ445
	HSK-PC Power Connection and End Seal Kit	Heat shrink power and end termination for CPR heat trace cables. CSA approved for grease waste, frost heave and freeze protection applications.	PJ957
	JBC-100 Junction Box to Conduit Connection Kit	NEMA 4X rated entry kit used to transition heating cable into a 1" NPT junction box entry to 1" NPT conduit.	PJ959

Accessories

Table 8 – Accessories Overview

	Catalog Number	Description	Instruction Manual
	AT-18 Aluminum Tape	180 ft roll of aluminum foil installation tape. 2-mil thickness with high tensile strength; 2-1/2" wide. 200°F (93°C) rating. Minimum application temperatures 40°F (5°C).	N/A
	FT-66 Fiberglass Tape	66 ft roll of glass cloth installation tape. 3/8" wide. 500°F (260°C) rating. Strap at one-foot intervals. Minimum application temperature 40°F (5°C).	N/A
	SS-1, SS-3, SS-10, SS-20 Stainless Steel Pipe Straps	One (1) pipe strap used to attach kits to pipe.	N/A
	WL-05 Caution Labels	Pack of five (5) weather resistant electric heat tracing caution labels.	N/A

Control Systems

Ambient Sensing

The ambient sensing control systems activate the heating cable when the ambient temperature falls below the thermostat set point. It is important that these devices are installed above ground at the pipe segment that is subject to the lowest temperatures and fastest wind speeds. The device should be placed out of direct sunlight.

The sensor must be secured to the pipe with aluminum tape and the insulation must be sealed where the capillary comes through. The device should be mounted above ground in an area without heavy pedestrian or equipment traffic. To avoid thermal interference with the sensor, it is important that the sensor is installed at 90 degrees from the nearest heating cable or centered equally between cables if more than one heating cable is used. The sensor should ideally be installed at the end of the circuit but can be installed at any location that is at least 3 feet away from any heat sinks. See installation detail AD17.

Line Sensing

The line sensing control systems activate the heating cable when the pipe temperature drops below the desired setpoint.

Table 9 – Thermostats and Sensors Overview















	Catalog Number	Description	Instruction Manual
	AS-BM Ambient Sensing Heat Trace RTD	RTD sensor of Copper sheath used for measuring ambient air temperature. Can be installed directly to controller or junction box using 1/2" NPT conduit fitting.	N/A
	LA-03, LA-10, LA-5 Ambient Sensing Heat Trace RTD	RTD 316 SS Sheath sensor of length 3', 10' or 50' with FEP insulation and 2" leads. Can be installed directly to controller or junction box using 1/2" conduit fitting.	N/A
	LN-03, LN-10, LN-50 Line Sensing Heat Trace RTD	RTD sensor of length 3', 10' or 50' with FEP insulation, flex armor, 1/2" fitting, and 18" leads.	N/A
	PS-AH Line Sensing Heat Trace RTD	RTD sensor of 316 SS Sheath with stainless steel mounting pad used for measuring surface temperature of piping or vessels.	N/A
	RTAS Ambient Sensing Thermostat and Power Connection Kit	NEMA 4X rated junction box with ambient sensing thermostat. Provides temperature control and termination for one (1) cable. One (1) additional cable can be connected upon purchase of additional grommet.	PJ953
	RTAS-EP Ambient Sensing Thermostat and Power Connection Kit	Modified version of the RTAS which utilizes a hermetically sealed switch. Class I, Division 2 approved.	PJ972
	RTBC Line Sensing Thermostat and Power Connection Kit	NEMA 4X rated junction box with line sensing thermostat; 8" stainless steel capillary. Provides temperature control and termination for one (1) cable.	PJ954
	RTBC-EP Line Sensing Thermostat and Power Connection Kit	Modified version of the RTBC which utilizes a hermetically sealed switch. Class I, Division 2 approved.	PJ973
	TPR Heat Trace Freeze Protection Thermostat	Thermostat with a fixed setpoint of 40°F (5°C) that can be used in ambient sensing or line sensing for freeze protection. Can be used to control a single heat trace circuit or as a pilot controller of a contactor switching multiple circuits.	N/A

Table 10. Thermostat Comparison

	AS-BM LA RTS	PS-AH LN RTBC	TPR
Control			
Ambient Sensing	✓		✓
Line Sensing		✓	✓
Location			
Local	✓	✓	✓
Remote			
Hazardous	RTAS-EP	PS-AH-93,94	

Controllers

Table 11 – Controllers Overview

	Catalog Number	Description	Instruction Manual
	Chroma-FP Commercial Freeze Protection Controller	Automatic control for freeze protection with user-friendly interface and adjustable temperature setpoint. Adjustable time delay of 0 to 99 hours.	PK568
	CTC IntelliTrace Commercial Controller	Microprocessor-based system with SSR power control, full monitoring, and alarms. Single or dual point control. NEMA 4X Fiberglass and stainless steel options available.	PK564
	CTS Commercial Heat Trace Electronic Thermostat	NEMA 4X rated enclosure with microprocessor-based temperature control and power connection. Provides easy programming of temperature setpoint, alarms, and deadband through panel push buttons.	PJ968
	ITC-FS IntelliTrace Digital Controller – Fire Sprinkler	Controller designed for freeze protection of fire sprinkler mains and branch lines. Offered in either a single circuit or an independently controlled and monitored dual circuit platform. NEMA 4X Fiberglass and stainless steel options available.	PK543
	CIP Commercial IntelliTrace Panel	Microprocessor-based control/monitoring and power management system for ambient sensing, line sensing or a combination of both. Capacity of 2-48 circuits but can be increased to 72 circuits with extension panel. User-friendly touch screen HMI. NEMA 4/4X options available.	PK563



	Catalog Number	Description	Instruction Manual
	RSP IntelliTrace Remote Sensor Panel	NEMA 4 Painted Steel, NEMA 4X Fiberglass or NEMA 4X 305SS enclosure. Fully integrated package that consolidates up to 252 temperature sensor signals in a single enclosure. Works seamlessly with the Chromalox IntelliTrace CIP heat trace control panels.	PK563
	WTP WeatherTrace Freeze Protection Ambient Sensing Panel	Provides group control of up to 24 heat trace circuits via an ambient sensing external thermostat, external electronic controller or via an external snow sensor. NEMA 4/4X options available.	N/A
	WTPM WeatherTrace Freeze Protection Ambient Sensing Panel-Monitoring	Monitors the supply voltage to each individual heat trace circuit. Provides group control of up to 24 heat trace circuits for pipe freeze protection via an ambient sensing thermostat, electronic controller, or door mounted HMI. NEMA 4/4X options available.	PK557

Table 12 – Controllers Comparison

	ChromaFP	CTC	CTS	ITC-FS	CIP	WTP	WTPM
Controls							
Ambient sensing	•	•	•	•	•	•	•
Line sensing		•	•	•	•		•
PASC		•			•		
Monitoring							
Ambient temperature	•	•	•	•	•	•	•
Pipe temperature		•	•	•	•		•
Ground fault	•	•		•	•	•	•
Current		•		•	•		
Location							
Local	•	•	•	•	•	•	•
Remote		•		•	•		
Hazardous		•	•		•*	•*	•*
Communications							
Local display	•	•	•	•	•		
Remote display	•	•		•	•		
Network to DCS	•	•		•	•		•
General							
Number of circuits	1	1-2	1	1-2	2-72	6-24	6-24
Sensor Mapping					•		
BACnet		•**		•**	•	•	•
Voltage	120, 240	110-277	110-277	110-277	120-480	120-480	120-480

*Not included in standard offering.

**Not included in standard offering and only available for single circuit use.

Thermal Insulation

An installed heating circuit should be thermally insulated immediately to provide protection from damage from on-going work. Things to remember about insulating:

- Insulate the equipment being heat traced as soon as possible after the heating cable is installed. This will protect the cable from possible physical damage.
- The type and thickness of thermal insulation specified on the design drawing must be used. If you use another type or thickness, the heater cable type or amount may have to be changed.
- Never install wet insulation. Both the piping and the insulation must be dry when thermally insulating a circuit. Wet insulation may cause start-up or operational problems.
- Properly weatherproof the thermal insulation. All places where valve stems, conduits, pipe supports, connection housing, thermal capillary tubes, etc. extend outside the insulation jacketing must be sealed with a suitable compound to keep water out.
- Insulate valves fully up to, and including, the packing gland.
- Heat trace and fully insulate the face of all non-diaphragm pressure instruments.

- Insulation must be covered by a weatherproof barrier, such as an aluminum jacket.
- If you are using metal jacketing and sheet metal screws, be sure the screws are not long enough to penetrate the thermal insulation and damage the heater cable.
- Again, perform the megger test on the circuit immediately after the thermal insulation is installed to detect if any mechanical damage may have occurred.
- When the insulation and the weatherproofing is complete, attach "Electric Traced" labels on the outside of the insulation. These should be installed where they are visible from normal operations, usually on alternating sides about every 10 feet. It is also useful to mark the location of any connections buried under the insulation.

Additional requirements for rigid thermal insulations:

- In the standard single heater cable installation, rigid insulations do not need to be oversized. However, they should be carved so there is no gap in the insulation.
- In case of redundant or multiple heater cables, rigid insulations which are 0.500 inches oversized should be used.

Commission Testing

1. Again, visually inspect the piping, insulation, and connections for the heater cable to make sure no physical damage has occurred since the installation and start-up.
2. Megger the system again to determine if damage not readily visible has occurred.
3. Turn all branch circuit breakers to the OFF position.

For systems controlled by ambient sensing thermostats:

1. If the actual ambient temperature is higher than the desired thermostat setting, turn the thermostat setting up high enough to turn the system ON or (some models) turn the selector switch to the ON position.
2. Turn the main circuit breaker ON.
3. Turn the branch breakers ON one-by-one until all are on.
4. Allow system to run at least four hours in order to let all pipes reach steady-state.
5. Measure the amperage draw, ambient temperature and pipe temperature for each circuit and record in the installation log. This information may be needed for future maintenance and troubleshooting.
6. When the system is completely checked out, reset the thermostat to the proper temperature.

For systems controlled by line sensing thermostats:

1. Set the thermostat to the desired control temperature.
2. Turn the main circuit breaker ON.
3. Turn ON the branch circuit breakers controlled by the thermostat.
4. Allow the pipe temperatures to be raised to the control point. This may take up to four hours for most circuits (large full pipes may take longer).
5. Measure the amperage draw, ambient temperature, and pipe temperature for each circuit and record in the installation log. This information may be needed for future maintenance and troubleshooting.

For redundant systems:

Follow the procedure above for the type of control system you have, but commission the systems one at a time. Start up the primary system, qualify it and shut it down. Then start up the backup system, qualify it and shut it down.

Specifications

Table 13 – CPR Circuit Breaker Selection for Pipe Freeze Protection (Max. Circuit Lengths in Ft.)

Cable Rating	40°F Start-up (Ft.)				20°F Start-up (Ft.)				0°F Start-up (Ft.)				-20°F Start-up (Ft.)				-40°F Start-up (Ft.)			
	15A	20A	30A	40A	15A	20A	30A	40A	15A	20A	30A	40A	15A	20A	30A	40A	15A	20A	30A	40A
CPR3-1	265	350	360	360	220	290	360	360	200	266	360	360	180	238	340	350	160	210	320	340
CPR3-2	525	660	660	660	440	585	660	660	415	553	660	660	368	489	628	643	320	425	595	625
CPR5-1	170	226	270	270	150	200	270	270	135	180	270	270	120	160	240	248	105	140	210	225
CPR5-2	340	450	540	540	300	400	540	540	270	360	540	540	243	323	485	525	215	286	430	510
CPR8-1	135	180	215	215	115	153	215	215	110	145	215	215	98	129	193	205	85	113	170	195
CPR8-2	270	330	420	420	235	310	420	420	200	265	395	420	188	238	355	410	175	210	315	400
CPR10-1	90	120	180	180	85	113	170	180	80	90	135	180	73	88	130	175	65	85	125	170
CPR10-2	150	200	300	360	140	185	280	360	125	166	250	333	118	156	233	313	110	145	215	293
CPR15-1	60	80	120	160	55	73	110	146	53	70	105	140	49	65	98	130	45	60	90	120
CPR15-2	95	125	190	250	90	110	180	230	75	100	150	200	70	93	140	187	65	86	130	173

Table 14 – CPR Circuit Breaker Selection for Grease Waste (Max. Circuit Lengths in Ft.)

Cable Rating	40°F Start-up (Ft.)				-40°F Start-up (Ft.)			
	15A	20A	30A	40A	15A	20A	30A	40A
CPR3-1	350	440	440	440	305	360	360	360
CPR3-2	680	800	825	825	600	660	660	660
CPR5-1	205	270	300	300	185	246	270	270
CPR5-2	410	546	620	620	375	500	540	540
CPR8-1	165	220	240	240	150	200	215	215
CPR8-2	310	412	480	480	285	375	420	420
CPR10-1	105	140	190	190	95	126	180	180
CPR10-2	210	230	345	345	160	210	315	360
CPR15-1	70	90	140	145	65	85	130	173
CPR15-2	105	140	210	220	100	133	200	265

Table 15 – CPM Circuit Breaker Selection (Max. Circuit Lengths in Ft.)

Cable Rating	50°F Start-Up (Ft.)				0°F Start-Up (Ft.)				-20°F Start-Up (Ft.)			
	15A	20A	30A	40A	15A	20A	30A	40A	15A	20A	30A	40A
CPM 5-1	162	216	324	338	149	198	297	338	160	210	320	340
CPM 5-2	324	432	648	675	293	387	581	675	320	425	595	625
CPM 8-1	131	171	257	293	122	158	239	293	105	140	210	225
CPM 8-2	257	342	518	585	230	311	468	585	215	284	425	510
CPM 10-1	86	113	171	225	81	99	158	225	85	113	170	195
CPM 10-2	171	230	347	441	149	203	311	441	175	210	315	400
CPM 15-1	63	86	131	171	59	77	113	149	65	85	125	170
CPM 15-2	131	171	261	347	108	158	243	324	110	145	215	293
CPM 20-1	54	68	104	140	45	59	95	126	41	59	90	122
CPM 20-2	104	140	207	275	90	122	180	243	81	117	176	230

Table 16 – CZH Cable Maximum Maintenance Temperatures

Output (W/Ft.)	Temperatures (°F)								
	3	4	6	6.7	8	9	10.1	10.6	12
w/o AT-18 Tape	340	325	293	282	262	246	229	222	200
w AT-18 Tape	350	344	332	328	320	314	307	304	296

Table 17– CZH Specifications

Model	Circuit Load (Amps / Ft.)	Max Circuit Length (Ft.)
CZH 4-1CT	0.033	350
CZH 8-1CT	0.067	240
CZH 12-1CT	0.100	200
CZH 4-2CT	0.017	700
CZH 8-2CT	0.033	480
CZH 12-2CT	0.050	400
CZH 12-4CT	0.025	780

Table 18 – HWM Tracing Selection

Cable Selection	
120V, 240V or 277V Maintain Temperature (°F) Cable	
105	HWM 5
115	HWM 10
125	HWM 10
140	HWM 10
208V Maintain Temperature (°F) Cable	
105	HWM 5
115	HWM 10
125	HWM 10
140	HWM 10

Table 19 – HWM Maximum Circuit Lengths

	Maximum Circuit Length (ft.)		
	15A	20A	30A
HWM5-1CT	200	270	400
HWM5-2CT	400	540	800
HWM10-1CT	130	155	220
HWM10-2CT	260	310	440

Table 20 – Commercial Heating Device Installation Type

Installation Type	Type Definition	Examples of Type		Cable Type
A	Insulated Surfaces (Including Pipe)	Hot water lines	Fuel oil lines	HWM CPR CPM CZH
		Freeze protection	Pre-insulated pipe	
		Sprinkler systems	Below grade trace heating	
		Grease lines		
B	Outdoor Exposed Areas	Roof deicing		CPR
		Gutter and down spout deicing		
		Catch basins and drains		
D	Installations with Trace Heater Inside Conduit or Piping	Snow melting trace heater in conduit	Enclosed drains and culverts	CPR CZH
		Frost heave protection in conduit	Energy storage systems in conduit	
		Floor warming in conduit		

Troubleshooting

Table 21 – Troubleshooting Guide

Observed Problem	Potential Causes	Corrective Actions
Pipe temperature is too low	Incorrect installation of thermostat/thermocouple	Reinstall thermostat on an appropriate pipe segment. Ensure thermocouple is fully contacting the pipe.
	Damaged, missing, or wet insulation	Remove damaged or wet insulation and install new, dry insulation. Ensure new insulation is weatherproofed.
	Improper installation of heating cable on heat sinks	Additional heating cable can be added, as long as the proper connection kits are used, and the new heating cable length does not exceed the maximum circuit length.
	Error in thermal design	Contact a Chromalox representative and modify design as needed.
	Incorrect voltage applied	Apply voltage as specified. Check/repair electrical supply lines.
Power output is too low	Damaged heating cable	Replace damaged cable. Check pipe temperature and cable power output.
	Incorrect circuit length due to uninstalled connections (splice/tee) or severed heating cable	Ensure length and heat trace path matches drawings.
	High-resistant connection due to improper installation of connection kits	Connect all splices and tees as per design specifications.
	Thermostat is wired in “Normally Open” position	Rewire to “Normally Closed” position
	The pipe temperature is too high	Lower pipe temperature if possible. Ensure correct heater selection and design. Contact a Chromalox representative and modify design if pipe temperature cannot be reduced.
Incorrect voltage applied	Apply voltage as specified. Check/repair electrical supply lines.	
Insulation resistance is low or inconsistent	Damaged heating cable	Replace damaged cable using the proper splice connection kits.
	Shorted circuit	Ensure all connection kits are installed properly and inspect them for damage. Replace if necessary.
		For uninsulated heating cable: Check the heating cable for damage, especially around heat sinks. Replace damaged cable using the proper connection kits.
		For insulated heating cable: Check the heating cable for damage piecewise at each connection kit to determine the damaged segment.
		The Locating Faults section on page 25 can be used to estimate fault location.
	Moisture	Excessive moisture on heating cable core or bus wires: Replace cable.
		Moisture on connection kits: Retest after drying out all components. Ensure all conduit entries are properly sealed during reinstallation.
Pipe temperature is too high	Retest at ambient conditions	
Test leads are in contact with junction box	Retest after moving test leads	

Observed Problem	Potential Causes	Corrective Actions
Circuit breaker trips	Undersized circuit breaker	Check design to ensure startup temperature, current loads, and maximum circuit length are not exceeded, and that the power wire size is compatible with the circuit breaker. Replace circuit breaker if necessary.
	Startup temperature is too low	Start up when temperature is higher than -76°F (-60°C).
	Damaged heating cable	Replace damaged cable using the proper connection kits.
	Bus wires touching and shorting out	Check for proper termination at end seal. Note that the heating cable could be permanently damaged and may need to be replaced.
	Moisture	Excessive moisture on heating cable core or bus wires: Replace cable.
		Moisture on connection kits: Retest after drying out all components. Ensure all conduit entries are properly sealed during reinstallation.
Undersized GFPD	Replace with appropriately sized GFPD.	

Test Procedures

⚠ WARNING

When testing any Chromalox heat trace product, always utilize the proper protective equipment and be sure to comply with all applicable safety guidelines.

⚠ WARNING

Before testing any Chromalox heat trace products, ensure that all test equipment is working as intended and has been properly calibrated.

⚠ WARNING

Only trained and qualified personnel should administer the test.

Locating Faults

The three most common test methods for finding the approximate location of a fault in a heating cable are:

- Ratio test
- Conductance test
- Capacitance test

Ratio Test

The ratio test can be used to approximate the fault location of a bus wire short or a fault from bus wire to ground braid. A standard ohmmeter is used to take resistance readings from both the front (F) and back (B) end of the cable. The fault location (L) as a percentage of cable length measured from the front end can be approximated by:

$$L (\%) = \frac{F}{F + B} * 100$$

To determine a bus wire short, the resistance reading is taken between the bus wires with one lead placed on each bus

wire. To determine a low resistance ground fault, the resistance reading is taken between the bus wires and the braid with one lead on bus wire and one on the braid.

Example: There is a bus wire short at an unknown point on a 100ft cable. The resistance reading between the bus wires is 6Ω from the front end of the cable and 14Ω from the back end.

$$L (\%) = \frac{6\Omega}{6\Omega + 14\Omega} * 100 = 30\%$$

The bus wire short is approximated to be 30ft (30% of 100ft) from the front end of the cable.

Conductance Test

The conductance test can be used to find the fault location of a severed heating cable. A standard ohmmeter is used to take resistance readings between the bus wires from both the front (F) and back (B) end of the cable. The fault location (L) as a percentage of cable length measured from the front end can be approximated by:

$$L (\%) = \frac{1/F}{1/F + 1/B} * 100$$

Example: A 100 ft long heating cable is severed at an unknown point. The bus-to-bus resistant reading is 10.0Ω from the front end and 2.5Ω from the back end.

$$L (\%) = \frac{1}{\frac{1}{10\Omega} + \frac{1}{2.5\Omega}} * 100 = 20\%$$

The cable is estimated to be severed at around 20ft (20% of 100ft) from the front of the cable.

Capacitance Test

The capacitance test can be used to estimate the length of an intact heating cable or the fault location of a severed cable that has passed the insulation resistance testing. A capacitance reading is taken between the bus wires and the braid at the end with the power connection. The bus wires should be twisted together and connected to the positive lead, and the braid should be connected to the negative lead. The fault location can be found by multiplying the recorded capacitance with the capacitance factor found in Table 18.

Example: A heating cable with a capacitance factor of 7 ft/nF is severed at an unknown point. The capacitance reading between the bus wires and the braid is 12 nF.

$$\text{Fault location} = 7 \frac{\text{ft}}{\text{nF}} * 12 \text{ nF} = 84 \text{ ft}$$

The cable is estimated to be severed at around 84ft from the power connection.

Table 22 – Capacitance Factors

Part Number	Description	Capacitance Factor (ft/nF)
CPR3-1CT/CR	3 W / FT @ 50°F - 120V	5.5
CPR3-2CT/CR	3 W / FT @ 50°F - 208-277V	5.9
CPR5-1CT/CR	5 W / FT @ 50°F - 120V	6.0
CPR5-2CT/CR	5 W / FT @ 50°F - 208-277V	5.4
CPR8-1CT/CR	8 W / FT @ 50°F - 120V	5.6
CPR8-2CT/CR	8 W / FT @ 50°F - 208-277V	5.5
CPR10-1CT/CR	10 W / FT @ 50°F - 120V	5.1
CPR10-2CT/CR	10 W / FT @ 50°F - 208-277V	5.2
CPR15-1CT/CR	15 W / FT @ 50°F - 120V	6.3
CPR15-2CT/CR	15 W / FT @ 50°F - 208-277V	5.8
CPM5-1CT	5 W / FT @ 50°F - 120V	7.5
CPM5-2CT	5 W / FT @ 50°F - 208-277V	7.2
CPM8-1CT	8 W / FT @ 50°F - 120V	8.0
CPM8-2CT	8 W / FT @ 50°F - 208-277V	7.6
CPM10-1CT	10 W / FT @ 50°F - 120V	7.5
CPM10-2CT	10 W / FT @ 50°F - 208-277V	7.5
CPM15-1CT	15 W / FT @ 50°F - 120V	8.0
CPM15-2CT	15 W / FT @ 50°F - 208-277V	8.0
CPM20-1CT	20W / FT @ 50°F - 120V	7.5
CPM20-2CT	20 W / FT @ 50°F - 208-277V	8.0

Insulation Resistance (Megger) Test

The insulation resistance test detects potential damage that could result in the cable shorting out. A megohmmeter is used to measure the insulation resistance between the conductive core and the grounding braid, and the reading is compared to the allowable minimum resistance reading (See Table 5). The megohmmeter should be a minimum of 1000 Vdc, but the use of 2500 Vdc is preferred. If possible, the meter should be battery-operated, though digital or analog meters can also be used.

1. De-energize the circuit.
2. Open the cover on the power termination kit.
3. Disconnect the bus wires and braid from the terminals.
4. Set the test voltage to 0 Vdc.
5. Connect the negative lead to the ground braid and the positive lead to the bus wires.
6. Turn on the megohmmeter and perform insulation resistance test for one minute, until the needle on the meter stops moving.
7. Check the reading and ensure it is above the allowable minimum resistance reading.
8. Record the tested value in the log.
9. Turn off the megohmmeter and discharge it with an appropriate grounding rod (if the meter does not self-discharge).
10. Reconnect the wires and close the power termination kit.

For additional information about this test, please watch the "Heat Trace Megger Testing Procedure" video in the Chromalox video library:

<https://www.chromalox.com/en/Resources-and-Support/Technical-Resources/Video-Library/Video-Library>

Stabilized Current Test

The stabilized current test determines the cable current at full voltage. It ensures that the cable power output is correct for design and that it is stable. To perform this test, a standard multimeter with an Amp clamp or an all-in-one unit is required. Ensure the meter has an auto-range up to 100A. If possible, the meter should be battery-operated, though digital or analog meters can also be used.

1. De-energize the circuit.
2. Open the cover on the power termination kit.
3. Disconnect the bus wires from the terminals.
4. Clamp the meter onto one bus wire.

5. Energize the circuit.
6. Allow the circuit to run for at least 20 minutes.
7. Take the current reading and record in the log.
8. De-energize the circuit.
9. Disconnect and turn off the meter.
10. Reconnect the bus wires and close the termination kit.

To determine the thermal output, complete the calculation below:

Thermal output = (Current Reading / Circuit Length) x Voltage

Compare the result to the charted output temperature in the "Chromalox Design Guide for Heat Tracing Products".

For additional information about this test, please watch the "Stabilized Current Test" video in the Chromalox video library: <https://www.chromalox.com/en/Resources-and-Support/Technical-Resources/Video-Library/Video-Library>

End of Current Voltage Test

This test determines the voltage at the end of the line, which verifies the proper voltage. To perform the test, a standard multimeter with auto-range up to 600V is required. If possible, the meter should be battery-operated, though digital or analog meters can also be used.

1. De-energize the circuit.
2. Remove the end cap.
3. Expose the bus wires.
4. Connect one test lead to each bus wire and energize the circuit
5. Read the resulting voltage and compare it to the desired value.
6. Record the reading in the test log.
7. De-energize the circuit.
8. Disconnect and turn off the multimeter.
9. Reconnect the end cap.

For additional information about this test, please watch the "End of Current Voltage Test" video in the Chromalox video library:

<https://www.chromalox.com/en/Resources-and-Support/Technical-Resources/Video-Library/Video-Library>

Maintenance

Recommended maintenance for Chromalox heat tracing systems consists of performing the steps involved in the commission testing on a regular basis. For those systems controlled by line sensing thermostats, Chromalox recommends checking the system at least twice per year. Systems controlled by an ambient-sensing thermostat should be checked when the season requiring their use is approaching.

Repair or replace all damaged heater cable, connections, thermal insulation and weatherproofing using only Chromalox connections and methods before testing the system.

Record all repairs made and measurements taken in the installation and maintenance log.

Installation and Maintenance Log

Reference Information

Circuit Number							
Circuit Breaker Number							
Drawing Number							
Circuit Length							

Heat Tracing Visual Checks

No Signs of Moisture, Corrosion or Damage	Initial						
	Date						
Proper Electrical Connection	Initial						
	Date						
Proper Grounding of the Braid	Initial						
	Date						

Heat Tracing Electrical Checks

Megger Test (500 VDC) (Bypass Controls)	Meg Ohms						
	Date						
Amperage Draw Test Compare to design Amperage Draw	Amperage						
	Amp. Temp						
	Date						
Voltage at end of Circuit*	Voltage						
	Date						

Accessories/Control Checks

Temperature Control Properly Set	Setpoint						
	Date						
Sensors Protected and Undamaged	Initial						
	Date						
All Enclosures and Kits Closed and Sealed	Initial						
	Date						

Thermal Insulation Checks

Location of Kits Visible on Outside of Insulation	Initial						
	Date						
Insulation is Complete, Dry and Weatherproof	Initial						
	Date						

* This test must be performed at installation or at any time the cable is cut or damaged in any way.

Limited Warranty:

Please refer to the Chromalox limited warranty applicable to this product at
<http://www.chromalox.com/customer-service/policies/termsofsale.aspx>.

Chromalox, Inc.
1347 Heil Quaker Boulevard
Lavergne, TN 37086
(615) 793-3900
www.chromalox.com

© 2021 Chromalox, Inc.